

74AUP1G373

Low-power D-type transparent latch; 3-state

Rev. 03 — 9 January 2008

Product data sheet

1. General description

The 74AUP1G373 provides the single D-type transparent latch with 3-state output. While the latch-enable (LE) input is high, the Q output follows the data (D) input. When pin LE is LOW, the latch stores the information that was present at the D-input one set-up time preceding the HIGH-to-LOW transition of pin LE. When pin \overline{OE} is LOW, the contents of the latch is available at the (Q) output. When pin \overline{OE} is HIGH, the output goes to the high-impedance OFF-state. Operation of input pin \overline{OE} does not affect the state of the latch.

Schmitt trigger action at all inputs makes the circuit tolerant to slower input rise and fall times across the entire V_{CC} range from 0.8 V to 3.6 V.

This device ensures a very low static and dynamic power consumption across the entire V_{CC} range from 0.8 V to 3.6 V.

This device is fully specified for partial power-down applications using I_{OFF} . The I_{OFF} circuitry disables the output, preventing the damaging backflow current through the device when it is powered down.

2. Features

- Wide supply voltage range from 0.8 V to 3.6 V
- High noise immunity
- Complies with JEDEC standards:
 - ◆ JESD8-12 (0.8 V to 1.3 V)
 - ◆ JESD8-11 (0.9 V to 1.65 V)
 - ◆ JESD8-7 (1.2 V to 1.95 V)
 - ◆ JESD8-5 (1.8 V to 2.7 V)
 - ◆ JESD8-B (2.7 V to 3.6 V)
- ESD protection:
 - ◆ HBM JESD22-A114E Class 3A exceeds 5000 V
 - ◆ MM JESD22-A115-A exceeds 200 V
 - ◆ CDM JESD22-C101-C exceeds 1000 V
- Low static power consumption; $I_{CC} = 0.9 \mu\text{A}$ (maximum)
- Latch-up performance exceeds 100 mA per JESD 78 Class II
- Inputs accept voltages up to 3.6 V
- Low noise overshoot and undershoot < 10 % of V_{CC}
- I_{OFF} circuitry provides partial Power-down mode operation
- Multiple package options
- Specified from $-40 \text{ }^\circ\text{C}$ to $+85 \text{ }^\circ\text{C}$ and $-40 \text{ }^\circ\text{C}$ to $+125 \text{ }^\circ\text{C}$

3. Ordering information

Table 1. Ordering information

Type number	Package			Version
	Temperature range	Name	Description	
74AUP1G373GW	-40 °C to +125 °C	SC-88	plastic surface-mounted package; 6 leads	SOT363
74AUP1G373GM	-40 °C to +125 °C	XSON6	plastic extremely thin small outline package; no leads; 6 terminals; body 1 × 1.45 × 0.5 mm	SOT886
74AUP1G373GF	-40 °C to +125 °C	XSON6	plastic extremely thin small outline package; no leads; 6 terminals; body 1 × 1 × 0.5 mm	SOT891

4. Marking

Table 2. Marking

Type number	Marking code
74AUP1G373GW	aW
74AUP1G373GM	aW
74AUP1G373GF	aW

5. Functional diagram

Fig 1. Logic symbol

Fig 2. IEC logic symbol

Fig 3. Logic diagram

6. Pinning information

6.1 Pinning

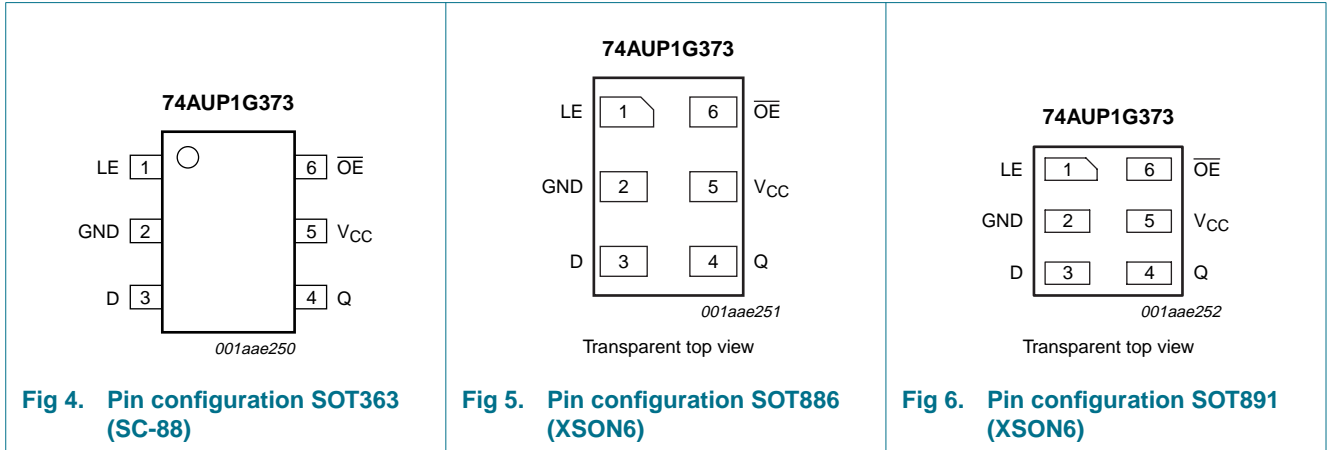

Fig 4. Pin configuration SOT363 (SC-88)

Fig 5. Pin configuration SOT886 (XSON6)

Fig 6. Pin configuration SOT891 (XSON6)

6.2 Pin description

Table 3. Pin description

Symbol	Pin	Description
LE	1	latch enable input (active HIGH)
GND	2	ground (0 V)
D	3	data input
Q	4	latch output
V _{CC}	5	supply voltage
\overline{OE}	6	output enable input (active LOW)

7. Functional description

Table 4. Function table^[1]

Operating modes	Input			Internal latch	Output Q
	\overline{OE}	LE	D		
Enable and read register (transparent mode)	L	H	L	L	L
	L	H	H	H	H
Latch and read register	L	L	l	L	L
	L	L	h	H	H
Latch register and disable outputs	H	X	X	X	Z

[1] H = HIGH voltage level;
 h = HIGH voltage level one setup time prior to the HIGH-to-LOW LE transition;
 L = LOW voltage level;
 l = LOW voltage level one setup time prior to the HIGH-to-LOW LE transition;
 X = Don't care;
 Z = high-impedance OFF-state.

8. Limiting values

Table 5. Limiting values

In accordance with the Absolute Maximum Rating System (IEC 60134). Voltages are referenced to GND (ground = 0 V).

Symbol	Parameter	Conditions	Min	Max	Unit
V _{CC}	supply voltage		-0.5	+4.6	V
I _{IK}	input clamping current	V _I < 0 V	-50	-	mA
V _I	input voltage		[1] -0.5	+4.6	V
I _{OK}	output clamping current	V _O > V _{CC} or V _O < 0 V	-	±50	mA
V _O	output voltage	Active mode and Power-down mode	[1] -0.5	+4.6	V
I _O	output current	V _O = 0 V to V _{CC}	-	±20	mA
I _{CC}	supply current		-	50	mA
I _{GND}	ground current		-50	-	mA
T _{stg}	storage temperature		-65	+150	°C
P _{tot}	total power dissipation	T _{amb} = -40 °C to +125 °C	[2] -	250	mW

[1] The input and output voltage ratings may be exceeded if the input and output current ratings are observed.

[2] For SC-88 packages: above 87.5 °C the value of P_{tot} derates linearly with 4.0 mW/K.
For XSON6 packages: above 45 °C the value of P_{tot} derates linearly with 2.4 mW/K.

9. Recommended operating conditions

Table 6. Recommended operating conditions

Symbol	Parameter	Conditions	Min	Max	Unit
V _{CC}	supply voltage		0.8	3.6	V
V _I	input voltage		0	3.6	V
V _O	output voltage	Active mode	0	V _{CC}	V
		Power-down mode; V _{CC} = 0 V	0	3.6	V
T _{amb}	ambient temperature		-40	+125	°C
Δt/ΔV	input transition rise and fall rate	V _{CC} = 0.8 V to 3.6 V	-	200	ns/V

10. Static characteristics

Table 7. Static characteristics

At recommended operating conditions; voltages are referenced to GND (ground = 0 V).

Symbol	Parameter	Conditions	Min	Typ	Max	Unit
T_{amb} = 25 °C						
V _{IH}	HIGH-level input voltage	V _{CC} = 0.8 V	0.70 × V _{CC}	-	-	V
		V _{CC} = 0.9 V to 1.95 V	0.65 × V _{CC}	-	-	V
		V _{CC} = 2.3 V to 2.7 V	1.6	-	-	V
		V _{CC} = 3.0 V to 3.6 V	2.0	-	-	V
V _{IL}	LOW-level input voltage	V _{CC} = 0.8 V	-	-	0.30 × V _{CC}	V
		V _{CC} = 0.9 V to 1.95 V	-	-	0.35 × V _{CC}	V
		V _{CC} = 2.3 V to 2.7 V	-	-	0.7	V
		V _{CC} = 3.0 V to 3.6 V	-	-	0.9	V

Table 7. Static characteristics ...continued

At recommended operating conditions; voltages are referenced to GND (ground = 0 V).

Symbol	Parameter	Conditions	Min	Typ	Max	Unit
V _{OH}	HIGH-level output voltage	V _I = V _{IH} or V _{IL}				
		I _O = -20 μA; V _{CC} = 0.8 V to 3.6 V	V _{CC} - 0.1	-	-	V
		I _O = -1.1 mA; V _{CC} = 1.1 V	0.75 × V _{CC}	-	-	V
		I _O = -1.7 mA; V _{CC} = 1.4 V	1.11	-	-	V
		I _O = -1.9 mA; V _{CC} = 1.65 V	1.32	-	-	V
		I _O = -2.3 mA; V _{CC} = 2.3 V	2.05	-	-	V
		I _O = -3.1 mA; V _{CC} = 2.3 V	1.9	-	-	V
		I _O = -2.7 mA; V _{CC} = 3.0 V	2.72	-	-	V
		I _O = -4.0 mA; V _{CC} = 3.0 V	2.6	-	-	V
V _{OL}	LOW-level output voltage	V _I = V _{IH} or V _{IL}				
		I _O = 20 μA; V _{CC} = 0.8 V to 3.6 V	-	-	0.1	V
		I _O = 1.1 mA; V _{CC} = 1.1 V	-	-	0.3 × V _{CC}	V
		I _O = 1.7 mA; V _{CC} = 1.4 V	-	-	0.31	V
		I _O = 1.9 mA; V _{CC} = 1.65 V	-	-	0.31	V
		I _O = 2.3 mA; V _{CC} = 2.3 V	-	-	0.31	V
		I _O = 3.1 mA; V _{CC} = 2.3 V	-	-	0.44	V
		I _O = 2.7 mA; V _{CC} = 3.0 V	-	-	0.31	V
		I _O = 4.0 mA; V _{CC} = 3.0 V	-	-	0.44	V
I _I	input leakage current	V _I = GND to 3.6 V; V _{CC} = 0 V to 3.6 V	-	-	±0.1	μA
I _{OZ}	OFF-state output current	V _I = V _{IH} or V _{IL} ; V _O = 0 V to 3.6 V; V _{CC} = 0 V to 3.6 V	-	-	±0.1	μA
I _{OFF}	power-off leakage current	V _I or V _O = 0 V to 3.6 V; V _{CC} = 0 V	-	-	±0.2	μA
ΔI _{OFF}	additional power-off leakage current	V _I or V _O = 0 V to 3.6 V; V _{CC} = 0 V to 0.2 V	-	-	±0.2	μA
I _{CC}	supply current	V _I = GND or V _{CC} ; I _O = 0 A; V _{CC} = 0.8 V to 3.6 V	-	-	0.5	μA
ΔI _{CC}	additional supply current	V _I = V _{CC} - 0.6 V; I _O = 0 A; V _{CC} = 3.3 V	[1]	-	40	μA
C _I	input capacitance	V _{CC} = 0 V to 3.6 V; V _I = GND or V _{CC}	-	0.8	-	pF
C _O	output capacitance	output enabled; V _O = GND; V _{CC} = 0 V	-	1.7	-	pF
		output disabled; V _{CC} = 0 V to 3.6 V; V _O = GND or V _{CC}	-	1.5	-	pF
T_{amb} = -40 °C to +85 °C						
V _{IH}	HIGH-level input voltage	V _{CC} = 0.8 V	0.70 × V _{CC}	-	-	V
		V _{CC} = 0.9 V to 1.95 V	0.65 × V _{CC}	-	-	V
		V _{CC} = 2.3 V to 2.7 V	1.6	-	-	V
		V _{CC} = 3.0 V to 3.6 V	2.0	-	-	V
V _{IL}	LOW-level input voltage	V _{CC} = 0.8 V	-	-	0.30 × V _{CC}	V
		V _{CC} = 0.9 V to 1.95 V	-	-	0.35 × V _{CC}	V
		V _{CC} = 2.3 V to 2.7 V	-	-	0.7	V
		V _{CC} = 3.0 V to 3.6 V	-	-	0.9	V

Table 7. Static characteristics ...continued

At recommended operating conditions; voltages are referenced to GND (ground = 0 V).

Symbol	Parameter	Conditions	Min	Typ	Max	Unit
V _{OH}	HIGH-level output voltage	V _I = V _{IH} or V _{IL}				
		I _O = -20 μA; V _{CC} = 0.8 V to 3.6 V	V _{CC} - 0.1	-	-	V
		I _O = -1.1 mA; V _{CC} = 1.1 V	0.7 × V _{CC}	-	-	V
		I _O = -1.7 mA; V _{CC} = 1.4 V	1.03	-	-	V
		I _O = -1.9 mA; V _{CC} = 1.65 V	1.30	-	-	V
		I _O = -2.3 mA; V _{CC} = 2.3 V	1.97	-	-	V
		I _O = -3.1 mA; V _{CC} = 2.3 V	1.85	-	-	V
		I _O = -2.7 mA; V _{CC} = 3.0 V	2.67	-	-	V
		I _O = -4.0 mA; V _{CC} = 3.0 V	2.55	-	-	V
V _{OL}	LOW-level output voltage	V _I = V _{IH} or V _{IL}				
		I _O = 20 μA; V _{CC} = 0.8 V to 3.6 V	-	-	0.1	V
		I _O = 1.1 mA; V _{CC} = 1.1 V	-	-	0.3 × V _{CC}	V
		I _O = 1.7 mA; V _{CC} = 1.4 V	-	-	0.37	V
		I _O = 1.9 mA; V _{CC} = 1.65 V	-	-	0.35	V
		I _O = 2.3 mA; V _{CC} = 2.3 V	-	-	0.33	V
		I _O = 3.1 mA; V _{CC} = 2.3 V	-	-	0.45	V
		I _O = 2.7 mA; V _{CC} = 3.0 V	-	-	0.33	V
		I _O = 4.0 mA; V _{CC} = 3.0 V	-	-	0.45	V
I _I	input leakage current	V _I = GND to 3.6 V; V _{CC} = 0 V to 3.6 V	-	-	±0.5	μA
I _{OZ}	OFF-state output current	V _I = V _{IH} or V _{IL} ; V _O = 0 V to 3.6 V; V _{CC} = 0 V to 3.6 V	-	-	±0.5	μA
I _{OFF}	power-off leakage current	V _I or V _O = 0 V to 3.6 V; V _{CC} = 0 V	-	-	±0.5	μA
ΔI _{OFF}	additional power-off leakage current	V _I or V _O = 0 V to 3.6 V; V _{CC} = 0 V to 0.2 V	-	-	±0.6	μA
I _{CC}	supply current	V _I = GND or V _{CC} ; I _O = 0 A; V _{CC} = 0.8 V to 3.6 V	-	-	0.9	μA
ΔI _{CC}	additional supply current	V _I = V _{CC} - 0.6 V; I _O = 0 A; V _{CC} = 3.3 V	[1]	-	50	μA
T_{amb} = -40 °C to +125 °C						
V _{IH}	HIGH-level input voltage	V _{CC} = 0.8 V	0.75 × V _{CC}	-	-	V
		V _{CC} = 0.9 V to 1.95 V	0.70 × V _{CC}	-	-	V
		V _{CC} = 2.3 V to 2.7 V	1.6	-	-	V
		V _{CC} = 3.0 V to 3.6 V	2.0	-	-	V
V _{IL}	LOW-level input voltage	V _{CC} = 0.8 V	-	-	0.25 × V _{CC}	V
		V _{CC} = 0.9 V to 1.95 V	-	-	0.30 × V _{CC}	V
		V _{CC} = 2.3 V to 2.7 V	-	-	0.7	V
		V _{CC} = 3.0 V to 3.6 V	-	-	0.9	V

Table 7. Static characteristics ...continued

At recommended operating conditions; voltages are referenced to GND (ground = 0 V).

Symbol	Parameter	Conditions	Min	Typ	Max	Unit
V _{OH}	HIGH-level output voltage	V _I = V _{IH} or V _{IL}				
		I _O = -20 μA; V _{CC} = 0.8 V to 3.6 V	V _{CC} - 0.11	-	-	V
		I _O = -1.1 mA; V _{CC} = 1.1 V	0.6 × V _{CC}	-	-	V
		I _O = -1.7 mA; V _{CC} = 1.4 V	0.93	-	-	V
		I _O = -1.9 mA; V _{CC} = 1.65 V	1.17	-	-	V
		I _O = -2.3 mA; V _{CC} = 2.3 V	1.77	-	-	V
		I _O = -3.1 mA; V _{CC} = 2.3 V	1.67	-	-	V
		I _O = -2.7 mA; V _{CC} = 3.0 V	2.40	-	-	V
		I _O = -4.0 mA; V _{CC} = 3.0 V	2.30	-	-	V
V _{OL}	LOW-level output voltage	V _I = V _{IH} or V _{IL}				
		I _O = 20 μA; V _{CC} = 0.8 V to 3.6 V	-	-	0.11	V
		I _O = 1.1 mA; V _{CC} = 1.1 V	-	-	0.33 × V _{CC}	V
		I _O = 1.7 mA; V _{CC} = 1.4 V	-	-	0.41	V
		I _O = 1.9 mA; V _{CC} = 1.65 V	-	-	0.39	V
		I _O = 2.3 mA; V _{CC} = 2.3 V	-	-	0.36	V
		I _O = 3.1 mA; V _{CC} = 2.3 V	-	-	0.50	V
		I _O = 2.7 mA; V _{CC} = 3.0 V	-	-	0.36	V
		I _O = 4.0 mA; V _{CC} = 3.0 V	-	-	0.50	V
I _I	input leakage current	V _I = GND to 3.6 V; V _{CC} = 0 V to 3.6 V	-	-	±0.75	μA
I _{OZ}	OFF-state output current	V _I = V _{IH} or V _{IL} ; V _O = 0 V to 3.6 V; V _{CC} = 0 V to 3.6 V	-	-	±0.75	μA
I _{OFF}	power-off leakage current	V _I or V _O = 0 V to 3.6 V; V _{CC} = 0 V	-	-	±0.75	μA
ΔI _{OFF}	additional power-off leakage current	V _I or V _O = 0 V to 3.6 V; V _{CC} = 0 V to 0.2 V	-	-	±0.75	μA
I _{CC}	supply current	V _I = GND or V _{CC} ; I _O = 0 A; V _{CC} = 0.8 V to 3.6 V	-	-	1.4	μA
ΔI _{CC}	additional supply current	V _I = V _{CC} - 0.6 V; I _O = 0 A; V _{CC} = 3.3 V	[1]	-	75	μA

[1] One input at V_{CC} - 0.6 V, other input at V_{CC} or GND.

11. Dynamic characteristics

Table 8. Dynamic characteristics

Voltages are referenced to GND (ground = 0 V); for test circuit see [Figure 11](#).

Symbol	Parameter	Conditions	25 °C			–40 °C to +125 °C				Unit
			Min	Typ ^[1]	Max	Min (85 °C)	Max (85 °C)	Min (125 °C)	Max (125 °C)	
C_L = 5 pF										
t _{pd}	propagation delay	D to Q; see Figure 7	[2]							
		V _{CC} = 0.8 V	-	21.4	-	-	-	-	-	ns
		V _{CC} = 1.1 V to 1.3 V	2.8	6.6	13.5	2.6	13.8	2.6	15.2	ns
		V _{CC} = 1.4 V to 1.6 V	2.4	4.6	7.8	2.1	8.3	2.1	9.1	ns
		V _{CC} = 1.65 V to 1.95 V	1.9	3.7	6.2	1.6	6.7	1.6	7.3	ns
		V _{CC} = 2.3 V to 2.7 V	1.8	2.9	4.1	1.5	4.5	1.5	4.9	ns
	V _{CC} = 3.0 V to 3.6 V	1.5	2.5	3.5	1.2	4.0	1.2	4.5	ns	
	LE to Q; see Figure 8	[2]								
		V _{CC} = 0.8 V	-	20.3	-	-	-	-	-	ns
		V _{CC} = 1.1 V to 1.3 V	2.7	6.2	13.6	2.5	14.0	2.5	15.4	ns
		V _{CC} = 1.4 V to 1.6 V	2.3	4.4	7.6	2.0	8.5	2.0	9.3	ns
		V _{CC} = 1.65 V to 1.95 V	1.8	3.5	5.8	1.5	6.7	1.5	7.3	ns
V _{CC} = 2.3 V to 2.7 V		1.5	2.6	4.0	1.3	4.4	1.3	4.8	ns	
V _{CC} = 3.0 V to 3.6 V	1.3	2.2	3.3	1.1	3.8	1.1	4.2	ns		
t _{en}	enable time	OE to Q; see Figure 10	[3]							
		V _{CC} = 0.8 V	-	17.9	-	-	-	-	-	ns
		V _{CC} = 1.1 V to 1.3 V	3.2	5.1	9.2	3.0	9.2	3.0	10.1	ns
		V _{CC} = 1.4 V to 1.6 V	2.6	3.8	5.8	2.4	6.1	2.4	6.7	ns
		V _{CC} = 1.65 V to 1.95 V	2.2	3.3	4.8	2.0	5.0	2.0	5.5	ns
		V _{CC} = 2.3 V to 2.7 V	2.0	2.7	3.8	1.8	4.0	1.8	4.4	ns
V _{CC} = 3.0 V to 3.6 V	1.9	2.5	3.4	1.8	3.6	1.8	4.0	ns		
t _{dis}	disable time	OE to Q; see Figure 10	[4]							
		V _{CC} = 0.8 V	-	9.4	-	-	-	-	-	ns
		V _{CC} = 1.1 V to 1.3 V	2.9	4.2	7.5	2.8	7.9	2.8	8.7	ns
		V _{CC} = 1.4 V to 1.6 V	2.2	3.2	4.9	2.1	5.3	2.1	5.8	ns
		V _{CC} = 1.65 V to 1.95 V	2.2	3.0	4.4	2.1	4.9	2.1	5.4	ns
		V _{CC} = 2.3 V to 2.7 V	1.6	2.2	3.1	1.5	3.4	1.5	3.7	ns
V _{CC} = 3.0 V to 3.6 V	1.9	2.6	3.3	1.8	3.6	1.8	4.0	ns		

Table 8. Dynamic characteristics ...continuedVoltages are referenced to GND (ground = 0 V); for test circuit see [Figure 11](#).

Symbol	Parameter	Conditions	25 °C			–40 °C to +125 °C				Unit
			Min	Typ ^[1]	Max	Min (85 °C)	Max (85 °C)	Min (125 °C)	Max (125 °C)	
C_L = 10 pF										
t _{pd}	propagation delay	D to Q; see Figure 7	[2]							
		V _{CC} = 0.8 V	-	24.4	-	-	-	-	-	ns
		V _{CC} = 1.1 V to 1.3 V	3.0	7.5	15.3	2.7	15.9	2.7	17.4	ns
		V _{CC} = 1.4 V to 1.6 V	2.6	5.3	9.0	2.2	9.4	2.2	10.3	ns
		V _{CC} = 1.65 V to 1.95 V	2.5	4.3	6.9	2.1	7.3	2.1	8.0	ns
		V _{CC} = 2.3 V to 2.7 V	2.0	3.5	4.8	1.8	5.3	1.8	5.9	ns
		V _{CC} = 3.0 V to 3.6 V	1.8	3.1	4.2	1.7	4.6	1.7	5.1	ns
		LE to Q; see Figure 8	[2]							
		V _{CC} = 0.8 V	-	23.3	-	-	-	-	-	ns
		V _{CC} = 1.1 V to 1.3 V	2.9	7.1	15.4	2.7	16.1	2.7	17.7	ns
		V _{CC} = 1.4 V to 1.6 V	2.5	5.0	8.8	2.1	9.5	2.1	10.4	ns
		V _{CC} = 1.65 V to 1.95 V	2.3	4.1	6.6	2.0	7.3	2.0	8.1	ns
		V _{CC} = 2.3 V to 2.7 V	1.9	3.1	4.7	1.6	5.2	1.6	5.8	ns
		V _{CC} = 3.0 V to 3.6 V	1.7	2.8	4.0	1.4	4.4	1.4	4.9	ns
t _{en}	enable time	$\overline{\text{OE}}$ to Q; see Figure 10	[3]							
		V _{CC} = 0.8 V	-	21.2	-	-	-	-	-	ns
		V _{CC} = 1.1 V to 1.3 V	3.7	6.0	10.6	3.4	10.6	3.4	11.7	ns
		V _{CC} = 1.4 V to 1.6 V	3.1	4.5	6.7	2.8	7.0	2.8	7.7	ns
		V _{CC} = 1.65 V to 1.95 V	2.7	3.9	5.5	2.5	5.8	2.5	6.4	ns
		V _{CC} = 2.3 V to 2.7 V	2.4	3.3	4.5	2.2	4.7	2.2	5.2	ns
		V _{CC} = 3.0 V to 3.6 V	2.3	3.1	4.1	2.2	4.3	2.2	4.7	ns
t _{dis}	disable time	$\overline{\text{OE}}$ to Q; see Figure 10	[4]							
		V _{CC} = 0.8 V	-	11.3	-	-	-	-	-	ns
		V _{CC} = 1.1 V to 1.3 V	3.9	5.3	8.7	3.8	9.2	3.8	10.1	ns
		V _{CC} = 1.4 V to 1.6 V	3.0	4.1	5.8	2.9	6.2	2.9	6.8	ns
		V _{CC} = 1.65 V to 1.95 V	3.2	4.2	5.7	3.1	6.0	3.1	6.6	ns
		V _{CC} = 2.3 V to 2.7 V	2.3	3.0	4.0	2.2	4.3	2.2	4.7	ns
		V _{CC} = 3.0 V to 3.6 V	3.0	3.8	4.7	2.9	5.0	2.9	5.5	ns

Table 8. Dynamic characteristics ...continued

Voltages are referenced to GND (ground = 0 V); for test circuit see [Figure 11](#).

Symbol	Parameter	Conditions	25 °C			–40 °C to +125 °C				Unit
			Min	Typ ^[1]	Max	Min (85 °C)	Max (85 °C)	Min (125 °C)	Max (125 °C)	
C_L = 15 pF										
t _{pd}	propagation delay	D to Q; see Figure 7	[2]							
		V _{CC} = 0.8 V	-	27.3	-	-	-	-	-	ns
		V _{CC} = 1.1 V to 1.3 V	3.5	8.3	16.9	3.2	17.5	3.2	19.2	ns
		V _{CC} = 1.4 V to 1.6 V	3.1	5.9	9.6	2.7	10.5	2.7	11.6	ns
		V _{CC} = 1.65 V to 1.95 V	2.6	4.8	7.6	2.2	8.5	2.2	9.3	ns
		V _{CC} = 2.3 V to 2.7 V	2.5	3.9	5.5	2.2	5.9	2.2	6.5	ns
		V _{CC} = 3.0 V to 3.6 V	2.2	3.6	4.9	1.8	5.5	1.8	6.0	ns
		LE to Q; see Figure 8	[2]							
		V _{CC} = 0.8 V	-	26.1	-	-	-	-	-	ns
		V _{CC} = 1.1 V to 1.3 V	3.3	7.9	17.3	3.0	18.0	3.0	19.8	ns
		V _{CC} = 1.4 V to 1.6 V	3.0	5.6	9.7	2.5	10.7	2.5	11.8	ns
		V _{CC} = 1.65 V to 1.95 V	2.5	4.6	7.4	2.2	8.3	2.2	9.1	ns
		V _{CC} = 2.3 V to 2.7 V	2.3	3.6	5.3	2.0	5.9	2.0	6.4	ns
		V _{CC} = 3.0 V to 3.6 V	2.1	3.2	4.6	1.8	5.1	1.8	5.6	ns
t _{en}	enable time	$\overline{\text{OE}}$ to Q; see Figure 10	[3]							
		V _{CC} = 0.8 V	-	24.6	-	-	-	-	-	ns
		V _{CC} = 1.1 V to 1.3 V	4.1	6.8	12.1	3.8	12.1	3.8	13.3	ns
		V _{CC} = 1.4 V to 1.6 V	3.5	5.1	7.5	3.2	7.9	3.2	8.7	ns
		V _{CC} = 1.65 V to 1.95 V	3.1	4.4	6.1	2.8	6.5	2.8	7.2	ns
		V _{CC} = 2.3 V to 2.7 V	2.8	3.7	5.0	2.5	5.3	2.5	5.8	ns
		V _{CC} = 3.0 V to 3.6 V	2.6	3.5	4.7	2.5	4.9	2.5	5.4	ns
t _{dis}	disable time	$\overline{\text{OE}}$ to Q; see Figure 10	[4]							
		V _{CC} = 0.8 V	-	13.1	-	-	-	-	-	ns
		V _{CC} = 1.1 V to 1.3 V	4.9	6.5	9.8	4.8	10.4	4.8	11.4	ns
		V _{CC} = 1.4 V to 1.6 V	3.9	5.0	6.8	3.8	7.3	3.8	8.0	ns
		V _{CC} = 1.65 V to 1.95 V	4.2	5.3	6.9	4.1	7.3	4.1	8.0	ns
		V _{CC} = 2.3 V to 2.7 V	3.0	3.8	4.8	2.9	5.1	2.9	5.6	ns
		V _{CC} = 3.0 V to 3.6 V	4.1	5.0	6.1	4.0	6.4	4.0	7.0	ns

Table 8. Dynamic characteristics ...continued

Voltages are referenced to GND (ground = 0 V); for test circuit see [Figure 11](#).

Symbol	Parameter	Conditions	25 °C			–40 °C to +125 °C				Unit
			Min	Typ ^[1]	Max	Min (85 °C)	Max (85 °C)	Min (125 °C)	Max (125 °C)	
C_L = 30 pF										
t _{pd}	propagation delay	D to Q; see Figure 7	[2]							
		V _{CC} = 0.8 V	-	35.9	-	-	-	-	-	ns
		V _{CC} = 1.1 V to 1.3 V	4.0	10.6	22.1	3.7	23.3	3.7	25.6	ns
		V _{CC} = 1.4 V to 1.6 V	3.6	7.5	12.3	3.5	13.6	3.5	15.0	ns
		V _{CC} = 1.65 V to 1.95 V	3.5	6.2	9.5	3.2	10.5	3.2	11.5	ns
		V _{CC} = 2.3 V to 2.7 V	3.3	5.1	6.9	2.9	7.6	2.9	8.3	ns
		V _{CC} = 3.0 V to 3.6 V	3.0	4.7	6.4	2.9	7.2	2.9	7.9	ns
		LE to Q; see Figure 8	[2]							
		V _{CC} = 0.8 V	-	34.8	-	-	-	-	-	ns
		V _{CC} = 1.1 V to 1.3 V	3.9	10.2	22.2	3.7	23.5	3.7	25.9	ns
		V _{CC} = 1.4 V to 1.6 V	3.5	7.2	12.4	3.4	13.7	3.4	15.1	ns
		V _{CC} = 1.65 V to 1.95 V	3.3	5.9	9.5	3.0	10.5	3.0	11.6	ns
		V _{CC} = 2.3 V to 2.7 V	3.1	4.8	6.8	2.7	7.5	2.7	8.2	ns
		V _{CC} = 3.0 V to 3.6 V	2.9	4.4	6.1	2.6	7.0	2.6	7.7	ns
t _{en}	enable time	$\overline{\text{OE}}$ to Q; see Figure 10	[3]							
		V _{CC} = 0.8 V	-	34.5	-	-	-	-	-	ns
		V _{CC} = 1.1 V to 1.3 V	5.5	9.1	16.2	4.9	16.2	4.9	17.8	ns
		V _{CC} = 1.4 V to 1.6 V	4.6	6.7	9.9	4.2	10.5	4.2	11.6	ns
		V _{CC} = 1.65 V to 1.95 V	4.2	5.7	7.9	3.7	8.6	3.7	9.5	ns
		V _{CC} = 2.3 V to 2.7 V	3.6	4.9	6.4	3.4	6.9	3.4	7.6	ns
		V _{CC} = 3.0 V to 3.6 V	3.4	4.7	6.1	3.3	6.5	3.3	7.2	ns
t _{dis}	disable time	$\overline{\text{OE}}$ to Q; see Figure 10	[4]							
		V _{CC} = 0.8 V	-	19.2	-	-	-	-	-	ns
		V _{CC} = 1.1 V to 1.3 V	8.0	9.9	13.7	7.9	14.5	7.9	16.0	ns
		V _{CC} = 1.4 V to 1.6 V	6.3	7.7	9.7	6.2	10.5	6.2	11.6	ns
		V _{CC} = 1.65 V to 1.95 V	7.3	8.7	10.6	7.2	11.3	7.2	12.4	ns
		V _{CC} = 2.3 V to 2.7 V	5.2	6.2	7.5	5.1	7.8	5.1	8.6	ns
		V _{CC} = 3.0 V to 3.6 V	7.5	8.8	10.2	7.4	10.5	7.4	11.6	ns
C_L = 5 pF, 10 pF, 15 pF and 30 pF										
t _w	pulse width	LE HIGH; see Figure 8								
		V _{CC} = 0.8 V	-	4.0	-	-	-	-	-	ns
		V _{CC} = 1.1 V to 1.3 V	-	0.7	-	2.1	-	2.1	-	ns
		V _{CC} = 1.4 V to 1.6 V	-	0.5	-	1.3	-	1.3	-	ns
		V _{CC} = 1.65 V to 1.95 V	-	0.4	-	1.0	-	1.0	-	ns
		V _{CC} = 2.3 V to 2.7 V	-	0.3	-	0.8	-	0.8	-	ns
		V _{CC} = 3.0 V to 3.6 V	-	0.2	-	0.8	-	0.8	-	ns

Table 8. Dynamic characteristics ...continuedVoltages are referenced to GND (ground = 0 V); for test circuit see [Figure 11](#).

Symbol	Parameter	Conditions	25 °C			–40 °C to +125 °C				Unit
			Min	Typ ^[1]	Max	Min (85 °C)	Max (85 °C)	Min (125 °C)	Max (125 °C)	
$t_{su(H)}$	set-up time HIGH	D to LE; see Figure 9								
		$V_{CC} = 0.8\text{ V}$	-	4.6	-	-	-	-	-	ns
		$V_{CC} = 1.1\text{ V to }1.3\text{ V}$	-	0.9	-	2.2	-	2.2	-	ns
		$V_{CC} = 1.4\text{ V to }1.6\text{ V}$	-	0.6	-	1.4	-	1.4	-	ns
		$V_{CC} = 1.65\text{ V to }1.95\text{ V}$	-	0.4	-	1.0	-	1.0	-	ns
		$V_{CC} = 2.3\text{ V to }2.7\text{ V}$	-	0	-	0.6	-	0.6	-	ns
		$V_{CC} = 3.0\text{ V to }3.6\text{ V}$	-	-0.1	-	0.4	-	0.4	-	ns
$t_{su(L)}$	set-up time LOW	D to LE; see Figure 9								
		$V_{CC} = 0.8\text{ V}$	-	4.0	-	-	-	-	-	ns
		$V_{CC} = 1.1\text{ V to }1.3\text{ V}$	-	1.2	-	2.7	-	2.7	-	ns
		$V_{CC} = 1.4\text{ V to }1.6\text{ V}$	-	0.7	-	1.5	-	1.5	-	ns
		$V_{CC} = 1.65\text{ V to }1.95\text{ V}$	-	0.6	-	1.2	-	1.2	-	ns
		$V_{CC} = 2.3\text{ V to }2.7\text{ V}$	-	0.4	-	0.9	-	0.9	-	ns
		$V_{CC} = 3.0\text{ V to }3.6\text{ V}$	-	0.3	-	0.7	-	0.7	-	ns
t_h	hold time	D to LE HIGH or LOW; see Figure 9								
		$V_{CC} = 0.8\text{ V}$	-	-4.6	-	-	-	-	-	ns
		$V_{CC} = 1.1\text{ V to }1.3\text{ V}$	-	-0.9	-	-0.1	-	-0.1	-	ns
		$V_{CC} = 1.4\text{ V to }1.6\text{ V}$	-	-0.6	-	-0.1	-	-0.1	-	ns
		$V_{CC} = 1.65\text{ V to }1.95\text{ V}$	-	-0.4	-	0	-	0	-	ns
		$V_{CC} = 2.3\text{ V to }2.7\text{ V}$	-	-0.2	-	0.2	-	0.2	-	ns
		$V_{CC} = 3.0\text{ V to }3.6\text{ V}$	-	-0.1	-	0.3	-	0.3	-	ns

Table 8. Dynamic characteristics ...continued

Voltages are referenced to GND (ground = 0 V); for test circuit see [Figure 11](#).

Symbol	Parameter	Conditions	25 °C			-40 °C to +125 °C				Unit
			Min	Typ ^[1]	Max	Min (85 °C)	Max (85 °C)	Min (125 °C)	Max (125 °C)	
C _{PD}	power dissipation capacitance	f _i = 1 MHz; V _I = GND to V _{CC} [5][6]								
		output enabled								
		V _{CC} = 0.8 V	-	2.0	-	-	-	-	-	pF
		V _{CC} = 1.1 V to 1.3 V	-	2.0	-	-	-	-	-	pF
		V _{CC} = 1.4 V to 1.6 V	-	2.0	-	-	-	-	-	pF
		V _{CC} = 1.65 V to 1.95 V	-	2.1	-	-	-	-	-	pF
		V _{CC} = 2.3 V to 2.7 V	-	2.4	-	-	-	-	-	pF
V _{CC} = 3.0 V to 3.6 V	-	2.8	-	-	-	-	-	pF		

- [1] All typical values are measured at nominal V_{CC}.
- [2] t_{pd} is the same as t_{PLH} and t_{PHL}.
- [3] t_{en} is the same as t_{PZH} and t_{PZL}.
- [4] t_{dis} is the same as t_{PHZ} and t_{PLZ}.
- [5] All specified values are the average typical values over all stated loads.
- [6] C_{PD} is used to determine the dynamic power dissipation (P_D in μW).
 $P_D = C_{PD} \times V_{CC}^2 \times f_i \times N + \Sigma(C_L \times V_{CC}^2 \times f_o)$ where:
 f_i = input frequency in MHz;
 f_o = output frequency in MHz;
 C_L = output load capacitance in pF;
 V_{CC} = supply voltage in V;
 $\Sigma(C_L \times V_{CC}^2 \times f_o)$ = sum of the outputs;
 N = number of inputs switching.

12. Waveforms

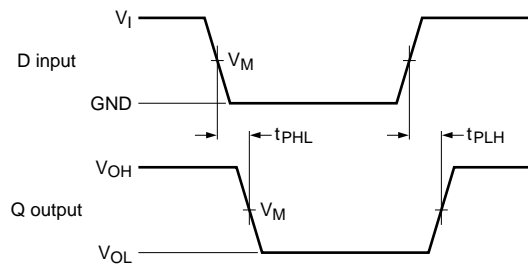

001aae253

Measurement points are given in [Table 9](#).

Logic levels: V_{OL} and V_{OH} are typical output voltage levels that occur with the output load.

Fig 7. The data input (D) to output (Q) propagation delays

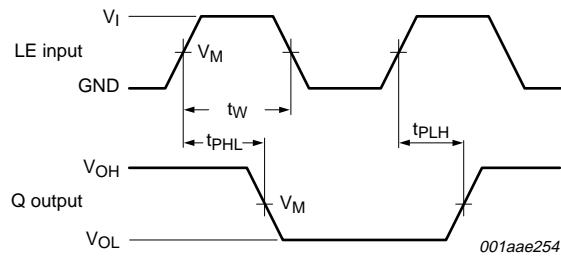

Measurement points are given in [Table 9](#).

Logic levels: V_{OL} and V_{OH} are typical output voltage levels that occur with the output load.

Fig 8. The latch enable input (LE) to output (Q) propagation delays, the latch enable input (LE) pulse width

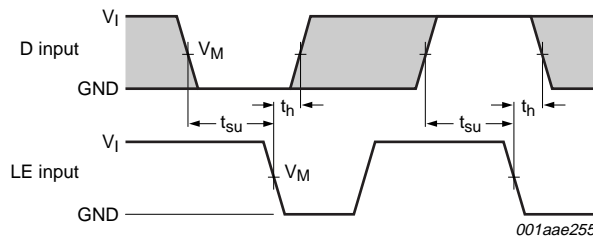

Measurement points are given in [Table 9](#).

Logic levels: V_{OL} and V_{OH} are typical output voltage levels that occur with the output load.

Fig 9. Data set-up and hold times for the D input to the LE input

Table 9. Measurement points

Supply voltage	Output	Input		
V_{CC}	V_M	V_M	V_I	$t_r = t_f$
0.8 V to 3.6 V	$0.5 \times V_{CC}$	$0.5 \times V_{CC}$	V_{CC}	≤ 3.0 ns

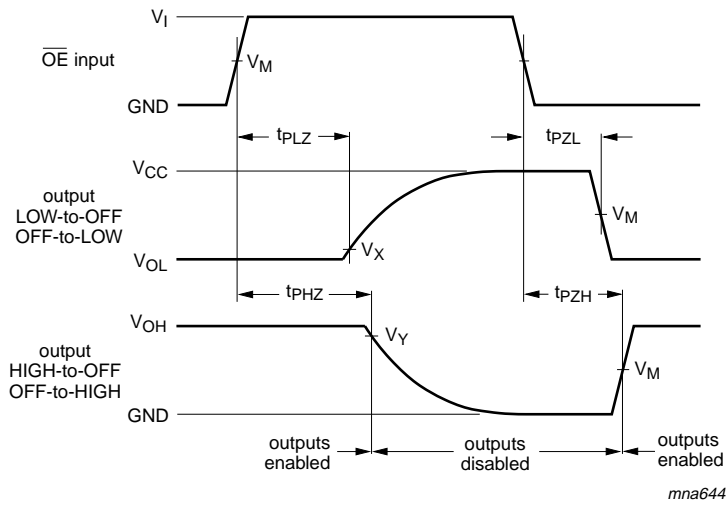

Measurement points are given in [Table 10](#).

Logic levels: V_{OL} and V_{OH} are typical output voltage levels that occur with the output load.

Fig 10. Turn-on and turn-off times

Table 10. Measurement points

Supply voltage	Input	Output		
V_{CC}	V_M	V_M	V_X	V_Y
0.8 V to 1.6 V	$0.5 \times V_{CC}$	$0.5 \times V_{CC}$	$V_{OL} + 0.1 V$	$V_{OH} - 0.1 V$
1.65 V to 2.7 V	$0.5 \times V_{CC}$	$0.5 \times V_{CC}$	$V_{OL} + 0.15 V$	$V_{OH} - 0.15 V$
3.0 V to 3.6 V	$0.5 \times V_{CC}$	$0.5 \times V_{CC}$	$V_{OL} + 0.3 V$	$V_{OH} - 0.3 V$

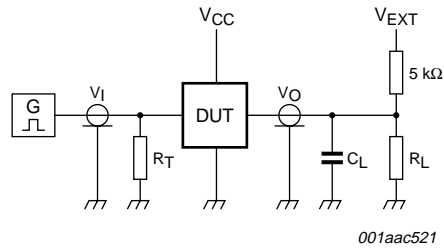

Test data is given in [Table 11](#).

Definitions for test circuit:

R_L = Load resistance.

C_L = Load capacitance including jig and probe capacitance.

R_T = Termination resistance should be equal to the output impedance Z_o of the pulse generator.

V_{EXT} = External voltage for measuring switching times.

Fig 11. Load circuitry for switching times

Table 11. Test data

Supply voltage	Load		V_{EXT}		
V_{CC}	C_L	R_L [1]	t_{PLH} , t_{PHL}	t_{PZH} , t_{PHZ}	t_{PZL} , t_{PLZ}
0.8 V to 3.6 V	5 pF, 10 pF, 15 pF and 30 pF	5 kΩ or 1 MΩ	open	GND	$2 \times V_{CC}$

[1] For measuring enable and disable times $R_L = 5\text{ k}\Omega$, for measuring propagation delays, setup and hold times and pulse width $R_L = 1\text{ M}\Omega$.

13. Package outline

Plastic surface-mounted package; 6 leads

SOT363

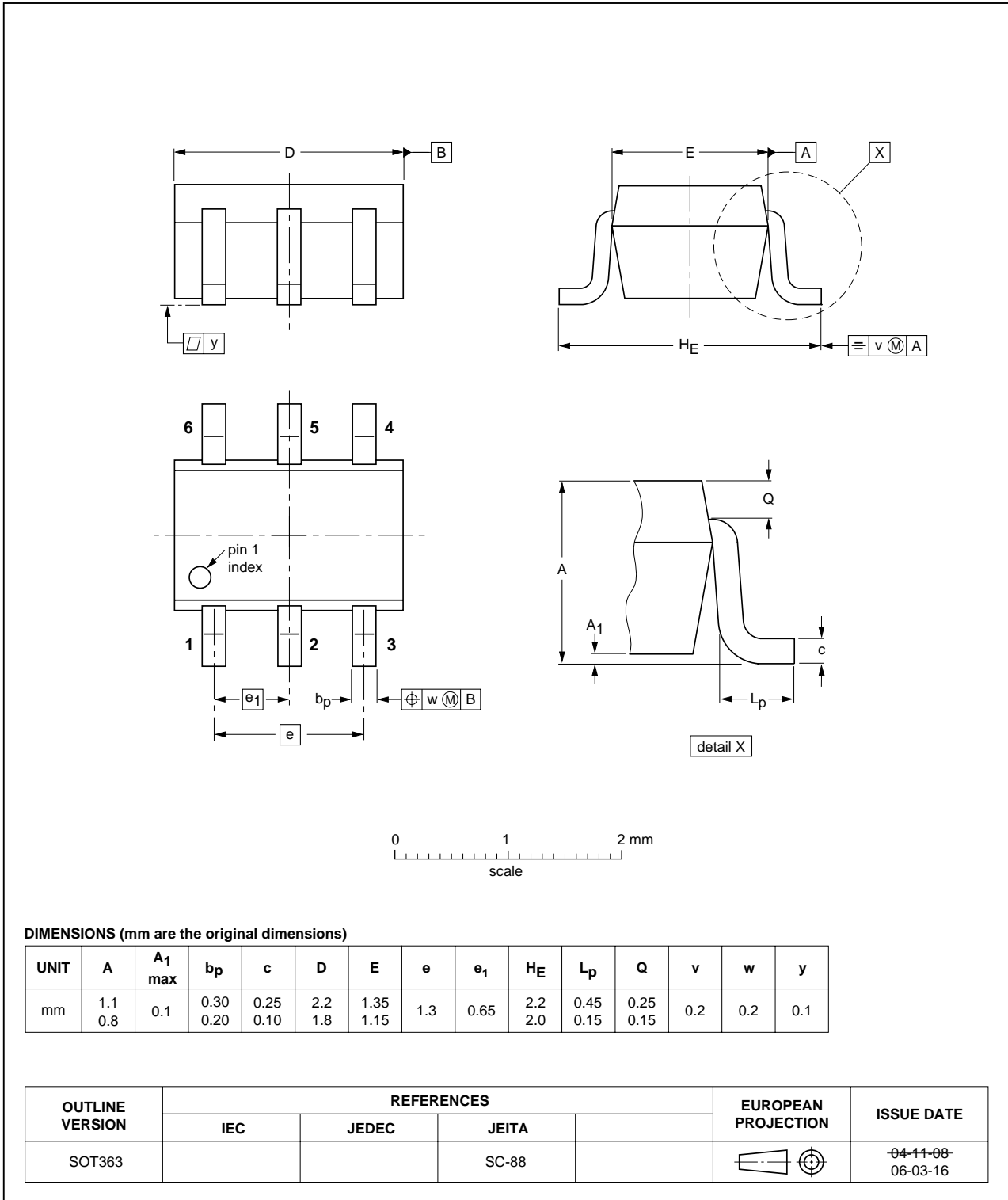

Fig 12. Package outline SOT363 (SC-88)

XSON6: plastic extremely thin small outline package; no leads; 6 terminals; body 1 x 1.45 x 0.5 mm

SOT886

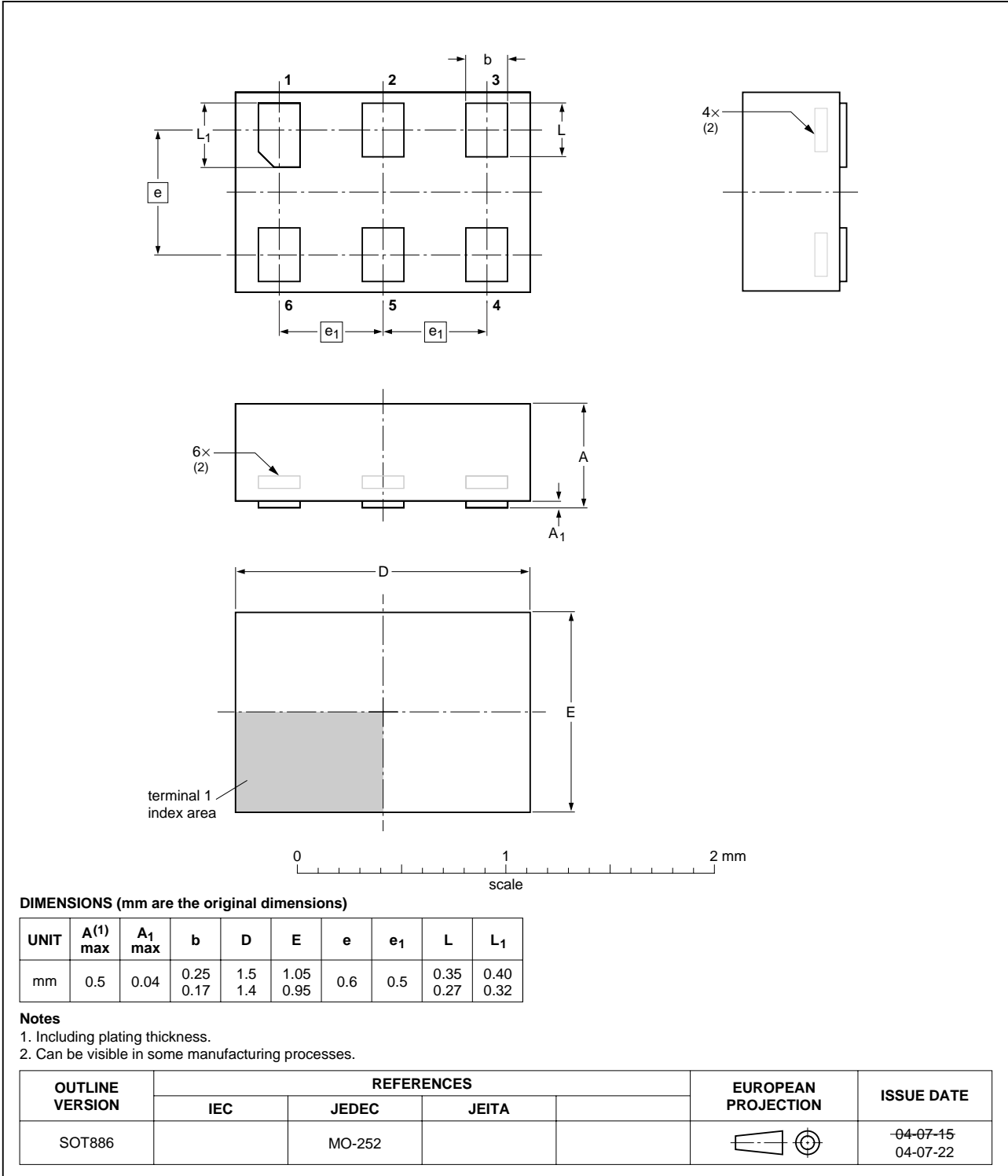

Fig 13. Package outline SOT886 (XSON6)

XSON6: plastic extremely thin small outline package; no leads; 6 terminals; body 1 x 1 x 0.5 mm

SOT891

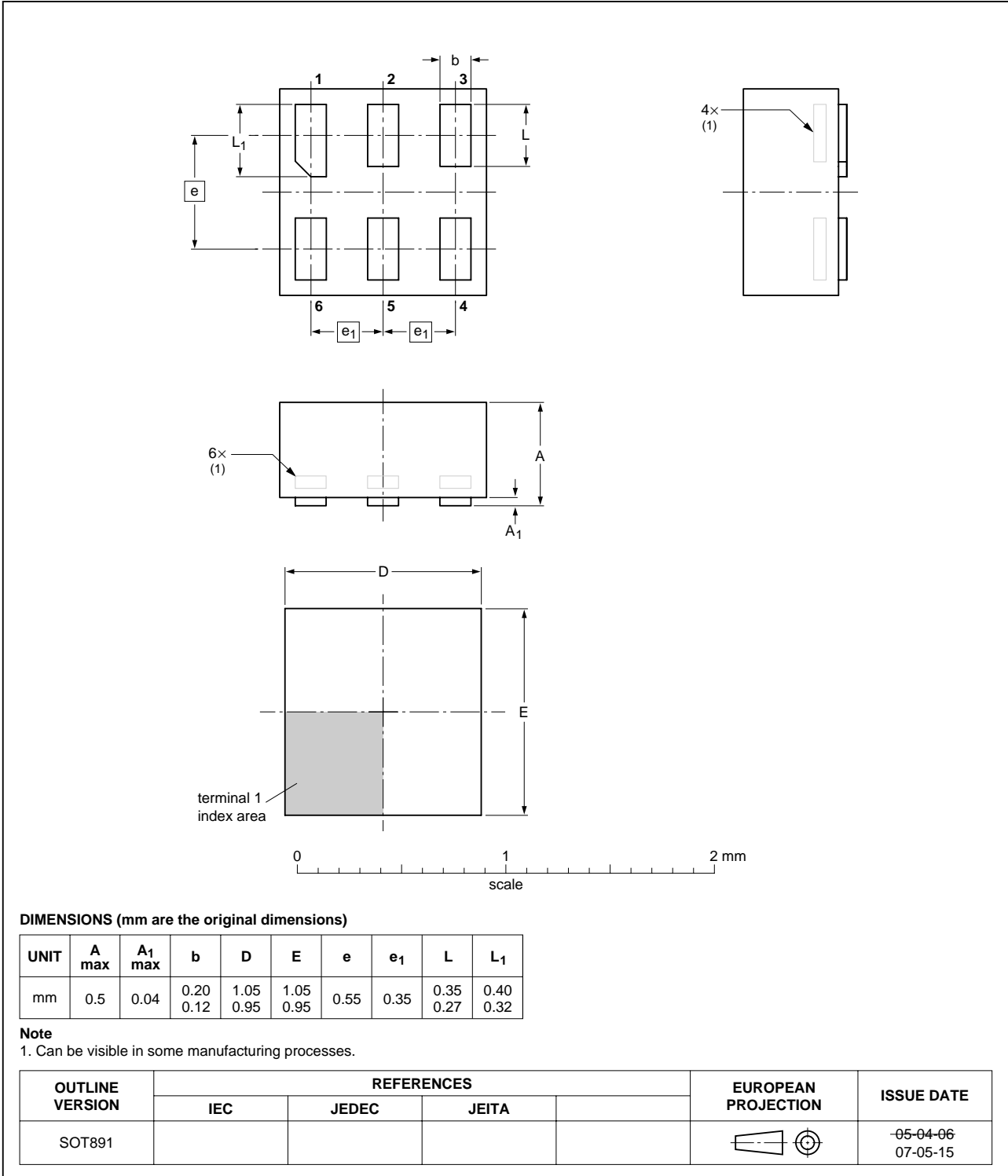

Fig 14. Package outline SOT891 (XSON6)

14. Abbreviations

Table 12. Abbreviations

Acronym	Description
CDM	Charged Device Model
CMOS	Complementary Metal Oxide Semiconductor
DUT	Device Under Test
ESD	ElectroStatic Discharge
HBM	Human Body Model
MM	Machine Model

15. Revision history

Table 13. Revision history

Document ID	Release date	Data sheet status	Change notice	Supersedes
74AUP1G373_3	20080109	Product data sheet	-	74AUP1G373_2
Modifications:	<ul style="list-style-type: none">• Section 11: Propagation delay, set-up and hold and power dissipation capacitance values have changed.			
74AUP1G373_2	20070720	Product data sheet	-	74AUP1G373_1
74AUP1G373_1	20061129	Product data sheet	-	-

16. Legal information

16.1 Data sheet status

Document status ^{[1][2]}	Product status ^[3]	Definition
Objective [short] data sheet	Development	This document contains data from the objective specification for product development.
Preliminary [short] data sheet	Qualification	This document contains data from the preliminary specification.
Product [short] data sheet	Production	This document contains the product specification.

[1] Please consult the most recently issued document before initiating or completing a design.

[2] The term 'short data sheet' is explained in section "Definitions".

[3] The product status of device(s) described in this document may have changed since this document was published and may differ in case of multiple devices. The latest product status information is available on the Internet at URL <http://www.nxp.com>.

16.2 Definitions

Draft — The document is a draft version only. The content is still under internal review and subject to formal approval, which may result in modifications or additions. NXP Semiconductors does not give any representations or warranties as to the accuracy or completeness of information included herein and shall have no liability for the consequences of use of such information.

Short data sheet — A short data sheet is an extract from a full data sheet with the same product type number(s) and title. A short data sheet is intended for quick reference only and should not be relied upon to contain detailed and full information. For detailed and full information see the relevant full data sheet, which is available on request via the local NXP Semiconductors sales office. In case of any inconsistency or conflict with the short data sheet, the full data sheet shall prevail.

16.3 Disclaimers

General — Information in this document is believed to be accurate and reliable. However, NXP Semiconductors does not give any representations or warranties, expressed or implied, as to the accuracy or completeness of such information and shall have no liability for the consequences of use of such information.

Right to make changes — NXP Semiconductors reserves the right to make changes to information published in this document, including without limitation specifications and product descriptions, at any time and without notice. This document supersedes and replaces all information supplied prior to the publication hereof.

Suitability for use — NXP Semiconductors products are not designed, authorized or warranted to be suitable for use in medical, military, aircraft, space or life support equipment, nor in applications where failure or

malfunction of an NXP Semiconductors product can reasonably be expected to result in personal injury, death or severe property or environmental damage. NXP Semiconductors accepts no liability for inclusion and/or use of NXP Semiconductors products in such equipment or applications and therefore such inclusion and/or use is at the customer's own risk.

Applications — Applications that are described herein for any of these products are for illustrative purposes only. NXP Semiconductors makes no representation or warranty that such applications will be suitable for the specified use without further testing or modification.

Limiting values — Stress above one or more limiting values (as defined in the Absolute Maximum Ratings System of IEC 60134) may cause permanent damage to the device. Limiting values are stress ratings only and operation of the device at these or any other conditions above those given in the Characteristics sections of this document is not implied. Exposure to limiting values for extended periods may affect device reliability.

Terms and conditions of sale — NXP Semiconductors products are sold subject to the general terms and conditions of commercial sale, as published at <http://www.nxp.com/profile/terms>, including those pertaining to warranty, intellectual property rights infringement and limitation of liability, unless explicitly otherwise agreed to in writing by NXP Semiconductors. In case of any inconsistency or conflict between information in this document and such terms and conditions, the latter will prevail.

No offer to sell or license — Nothing in this document may be interpreted or construed as an offer to sell products that is open for acceptance or the grant, conveyance or implication of any license under any copyrights, patents or other industrial or intellectual property rights.

16.4 Trademarks

Notice: All referenced brands, product names, service names and trademarks are the property of their respective owners.

17. Contact information

For additional information, please visit: <http://www.nxp.com>

For sales office addresses, send an email to: salesaddresses@nxp.com

18. Contents

1 **General description** 1

2 **Features** 1

3 **Ordering information** 2

4 **Marking** 2

5 **Functional diagram** 2

6 **Pinning information** 3

6.1 Pinning 3

6.2 Pin description 3

7 **Functional description** 3

8 **Limiting values** 4

9 **Recommended operating conditions** 4

10 **Static characteristics** 4

11 **Dynamic characteristics** 8

12 **Waveforms** 13

13 **Package outline** 17

14 **Abbreviations** 20

15 **Revision history** 20

16 **Legal information** 21

16.1 Data sheet status 21

16.2 Definitions 21

16.3 Disclaimers 21

16.4 Trademarks 21

17 **Contact information** 21

18 **Contents** 22

Please be aware that important notices concerning this document and the product(s) described herein, have been included in section 'Legal information'.



© NXP B.V. 2008.

All rights reserved.

For more information, please visit: <http://www.nxp.com>

For sales office addresses, please send an email to: salesaddresses@nxp.com

Date of release: 9 January 2008

Document identifier: 74AUP1G373_3